

Manual

Flat sensor AR

Flat sensor SP

Flat sensor RE

Control unit 10-fold



Version: 0902

Material number: 12002500013

1 Contents

1 Contents	2
2 Safety notes	4
3 Dimension drawings	5
4 General information on flat sensors	6
4.1 Housing shape	6
4.2 Variants	6
4.3 Sensitivity	7
5 Application	8
5.1 Single-sided scanning	8
5.2 Double-sided scanning (Sandwich)	8
6 Variations of the modular system	9
6.1 Rules for combination	9
6.2 Examples for sensor widths	10
7 Assembly	11
7.1 Flush mounting in metal	11
7.2 Montagebeispiele	11
7.3 Assembly notes	12
8 Technical data flat sensors	13
8.1 Flat sensor AR	13
8.2 Flat sensor SP	13
8.3 Flat sensor RE	13
9 Control unit 10-fold	14
9.1 Field of application, scope of performance and supply	14
9.2 Technical Data control unit 10-fold	14
9.3 Operating elements and connection terminals	15
9.4 Terminal assignment	17
9.5 DIP-switch and potentiometer adjustment	21
9.6 Initial operation	22
10 Motor contactor and wiring	23
10.1 Technical data motor contactor	23
10.2 Wiring examples	23

2 Safety notes

This technical document describes the function and operation of the control units 08349005000, 08349005001 and 08349005002 and the flat sensors. This documents does not deal with safety regulations, which arise from the customer-related application. These have to be observed by the user at his own responsibility. Device connection and adjustment have to be performed by qualified personnel with all safety and accident prevention regulations in mind. In particular the wiring and connection of all electrical components may only be carried out in the zero voltage state. The device may only be supplied with mains voltage once it has been connected professionally and correctly. The product-related safety notes in chapter 7 have to be minded.

3 Dimension drawings

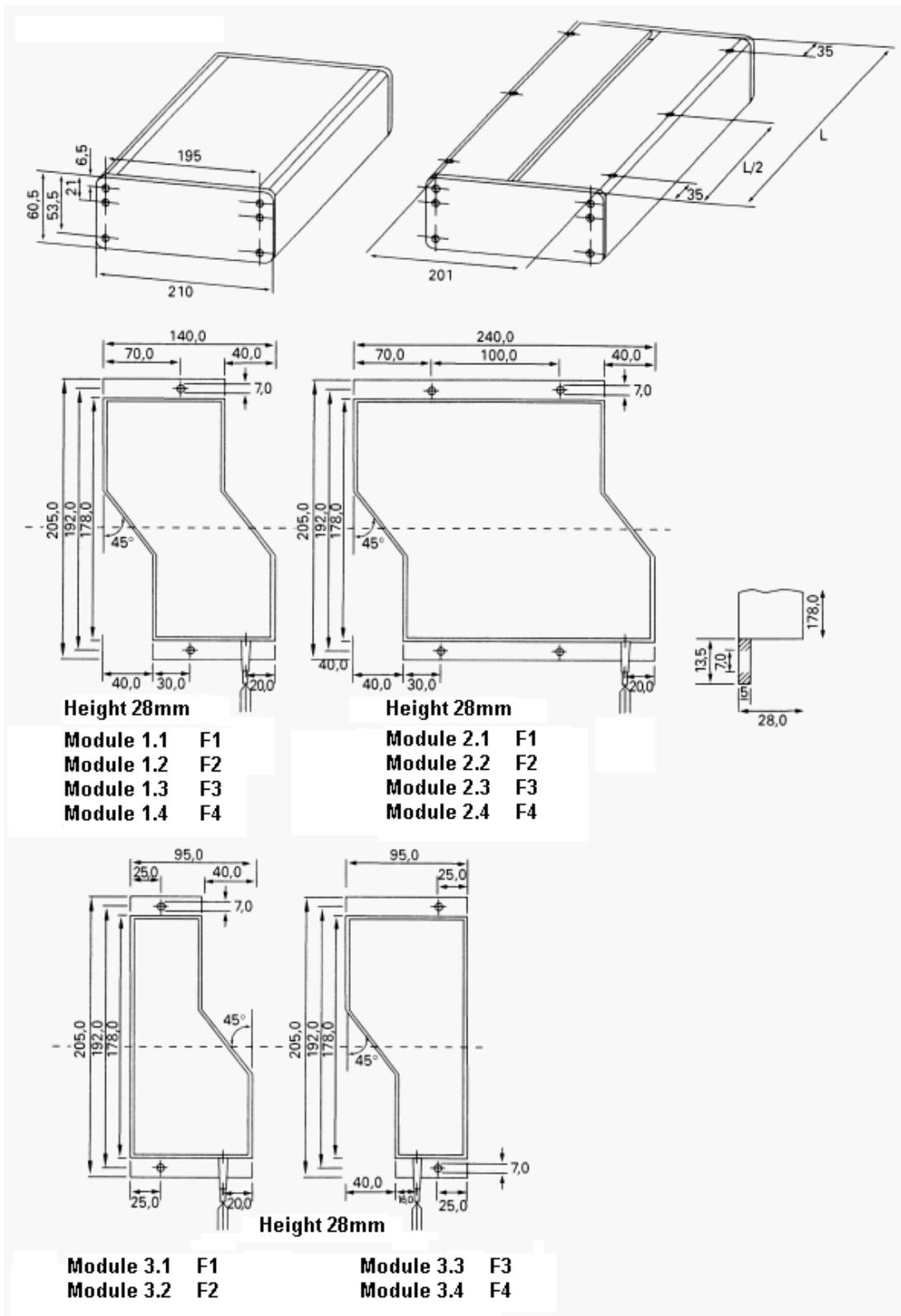

The modules 3.1, 3.2 and 3.3, 3.4 only differ from one to another mechanically due to the position of the cable. F1 to F4 are the numbers of the operating frequencies.

4 General information on flat sensors

Flat sensors can be integrated into slides and transport devices in order to detect metal (irrespective of which type) in the material being conveyed.

4.1 Housing shape

The sensors have an angled housing. This makes it possible to combine them together, since the sensor surfaces interlock. This helps prevent any zones with reduced sensitivity at the seams.

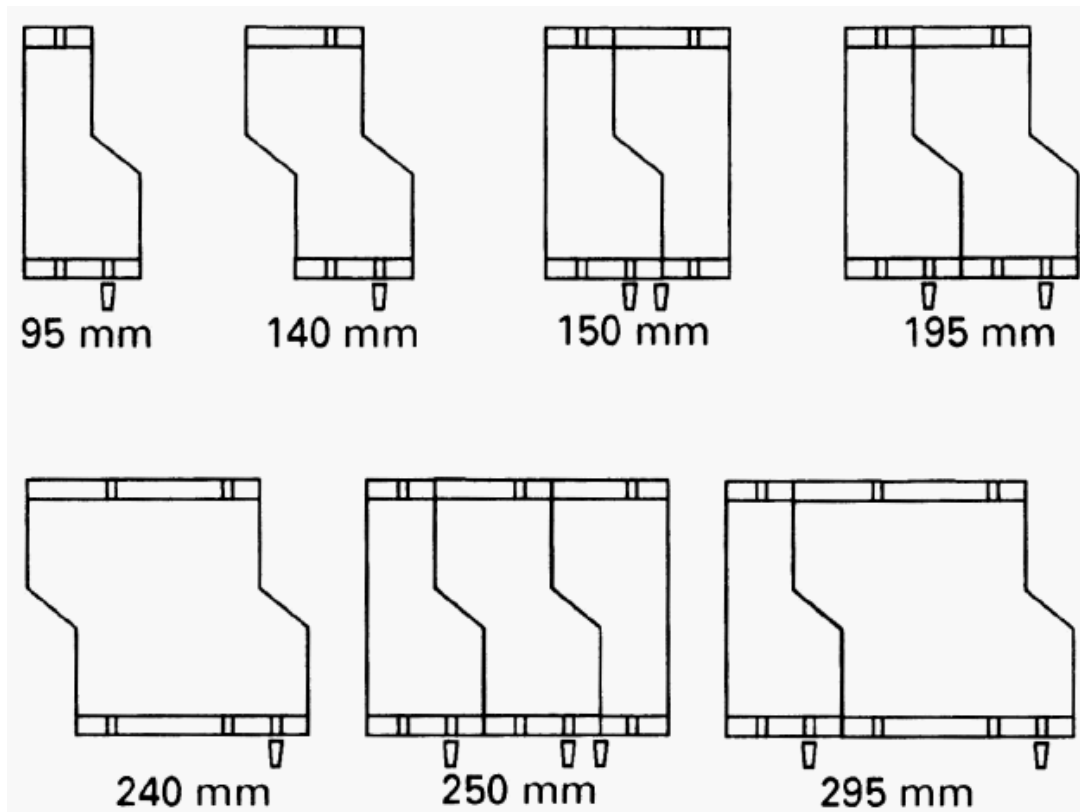

The housings interlock by 40 mm into one another when combining them, i.e. by chaining them together. The entire sensor area increases by the width of the adjoining sensor minus 40 mm.

4.2 Variants

The flat sensors generate an electromagnetic field, which detects metal parts. It is an alternating field, which alternates at a particular frequency. By combining the sensors the sensor fields overlap (as described above). The alternating field frequencies must be different to avoid both fields affecting each other through the overlapping. For this reason all four flat sensors are available with 4 different frequencies (F1-F4).

4.3 Sensitivity

All sensors of the same type have the same sensitivity. The highest sensitivity you get directly above the sensor surface. The sensitivity decreases with increasing distance from the sensor surface.

4.3.1 Sensitivity flat sensor AR

Metal part	is still registered at a distance of
Fe-ball Ø 2,0 mm	5mm
Fe-ball Ø 2,5 mm	10mm
Fe-ball Ø 3,0 mm	15mm
Fe-ball Ø 4,5 mm	24mm
Nut M2,5	26mm
Washer M3	26mm
Washer M4	29mm
Nut M4	35mm
Fe-ball Ø 7,0 mm	35mm
Nut M6	35mm
Fe-part 12 x 12 x 1 mm	55mm
Fe-part 30 x 30 x 1 mm	75mm

4.3.2 Sensitivity flat sensor SP

Metal part	is still registered at a distance of
Fe-ball Ø 2,0 mm	8mm
Fe-ball Ø 2,5 mm	14mm
Fe-ball Ø 3,0 mm	20mm
Fe-ball Ø 4,5 mm	30mm
Nut M2,5	33mm
Washer M3	33mm
Washer M4	37mm
Nut M4	44mm
Fe-ball Ø 7,0 mm	44mm
Nut M6	56mm
Fe-part 12 x 12 x 1 mm	68mm
Fe-part 30 x 30 x 1 mm	95mm

4.3.3 Sensitivity flat sensor RE

Metal part	is still registered at a distance of
Fe-ball Ø 2,0 mm	6mm
Fe-ball Ø 3 mm	12mm
Fe-ball Ø 3,5 mm	15mm
U-Scheibe M4	29mm
Nut M4	18mm
Fe-ball Ø 6,0 mm	44mm
Nut M6	40mm
Fe-part 12 x 12 x 1 mm	50mm
Fe-part 30 x 30 x 1 mm	70mm

5 Application

5.1 Single-sided scanning

Flat sensors scan the conveyed material from one side. It is unimportant whether this happens from above or below. Typical here is the assembly of the flat sensors beneath **or** above the conveyor belt.

5.2 Double-sided scanning (Sandwich)

Double-sided scanning is possible only with flat sensors of the type AR. Flat sensors scan the conveyed material on both sides. Typical here is the assembly beneath **and** above the conveyor belt. In a sandwich in contrast to single-sided sensing:

- The detection distance can be increased (with the metal part size being the same) or
- The sensitivity can be increased (within the same distance).

Example:

A nut M6 is detected up to a distance of 45 mm to the sensor surface with single-sided sensing. If in a sandwich a distance of 90 mm (2x45 mm) is chosen between the upper and lower flat sensors, the sensitivity still remains the same compared with the single-sided sensing. The nut M6 is thus safely detected over the entire area of 90 mm. This makes it possible for example to scan conveyed material that is stacked higher.

If in a sandwich a distance of 45 mm is chosen between the upper and lower sensor the sensitivity increases accordingly. A Fe-ball 4.5 mm Ø can be detected in the entire area of this sandwich (each of both sensor levels register the Fe-ball 4.5 mm Ø up to a distance of 24 mm).

6 Variations of the modular system

The following must be observed in order to avoid errors by the combination of the same type of flat sensors (refer to point 4.2):

6.1 Rules for combination

A minimum distance of 300 mm has to be between sensors with the same module number.

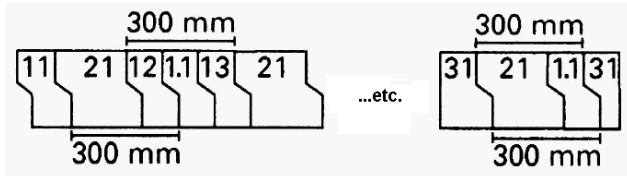

Different shaped flat sensors can be combined independently of the frequency.

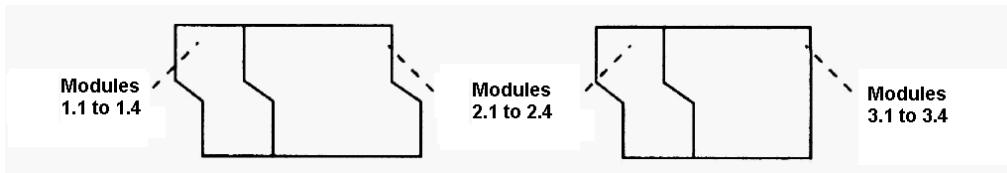

With double-sided sensing a minimum height of 40 mm must be observed between the upper and lower sensor.

There are basically 2 different possibilities for constructing a sandwich:

1. Flat sensors with the same shape are each positioned above one another. The repetition of one module number within such an expansion is not permitted. This means the maximum width attainable here is limited to 750 mm. Modules with a width of 95mm should always have different frequencies when used in a sandwich.

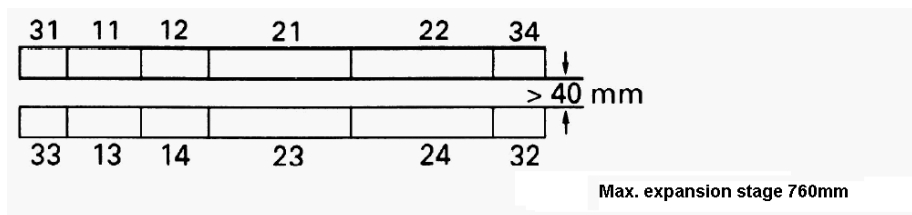

2. In the upper level only wide sensors and in the lower level only narrow sensors are used and vice versa. In this case the width is infinitely variable, but it has to be observed that a minimum distance of 600 mm must be kept between identical sensors of the type 2.x. The modules 3.1 to 3.4 can be used as shown above.

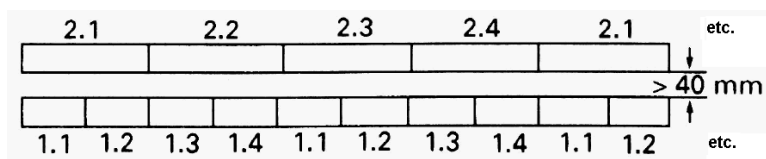

6.2 Examples for sensor widths

The following table shows all combination possibilities of flat sensors up to a total width of 1040 mm. Higher widths are also possible and can be derived from this table. In case of a sandwich construction please observe the corresponding explanations from 6.1!

Width in mm	Required sensors
95	95
140	140
150 – 160*	95 – 95
195 – 200*	95 – 140
240	240
250 – 260*	95 – 140 – 95
295 – 300*	95 – 240
340	140 – 240
350 – 360*	95 – 240 – 95
395 – 400*	95 – 140 – 240
440	240 – 240
450 – 460*	95 – 140 – 240 – 95
495 – 500*	95 – 240 – 240
540	140 – 240 – 240
550 – 560*	95 – 240 – 240 – 95
595 – 600*	95 – 140 – 240 – 240
640	240 – 240 – 240
350 – 660*	95 – 140 – 240 – 240 – 95
695 – 700*	95 – 240 – 240 – 240
740	140 – 240 – 240 – 420
750 – 760*	95 – 240 – 240 – 240 – 95
795 – 800*	95 – 140 – 240 – 240 – 240
840	240 – 240 – 240 – 240
850 – 860*	95 – 140 – 240 – 240 – 240 – 95
895 – 900*	95 – 240 – 240 – 240 – 240
940	140 – 240 – 240 – 240 – 240
950 – 960*	95 – 240 – 240 – 240 – 240 – 95
995 – 1000*	95 – 140 – 240 – 240 – 240 – 240
1040	240 – 240 – 240 – 240 – 240

* Without the sensitivity being influenced a maximum distance of 5 mm may be between a module with a width of 95mm and its neighbouring element. In this way the entire width can be enlarged accordingly.

7 Assembly

7.1 Flush mounting in metal

As far as metal is in-plane with the sensor surface it may have direct contact with the housing of the sensor. If metal protrudes higher than the level of the sensor surface next to the sensor a minimum distance of 20 mm has to be kept between the housing and the protruding metal.

7.2 Montagebeispiele

- Example for an assembly into the conveyor

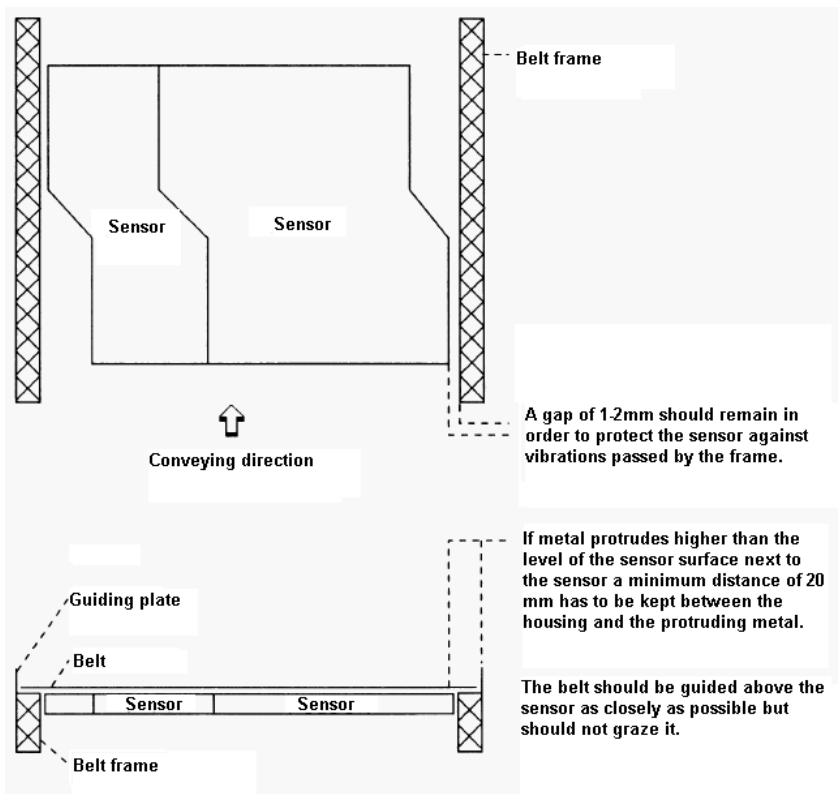

- Equipping a conveyor with a clear width of 300 mm between the frame arbors:

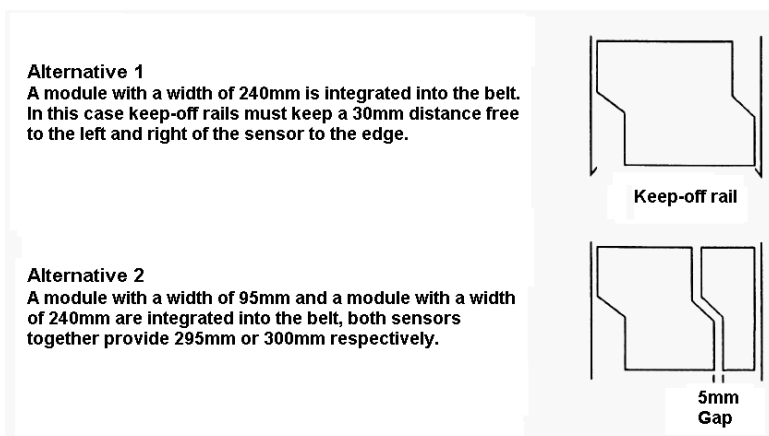

- Example for an assembly into a metal plane

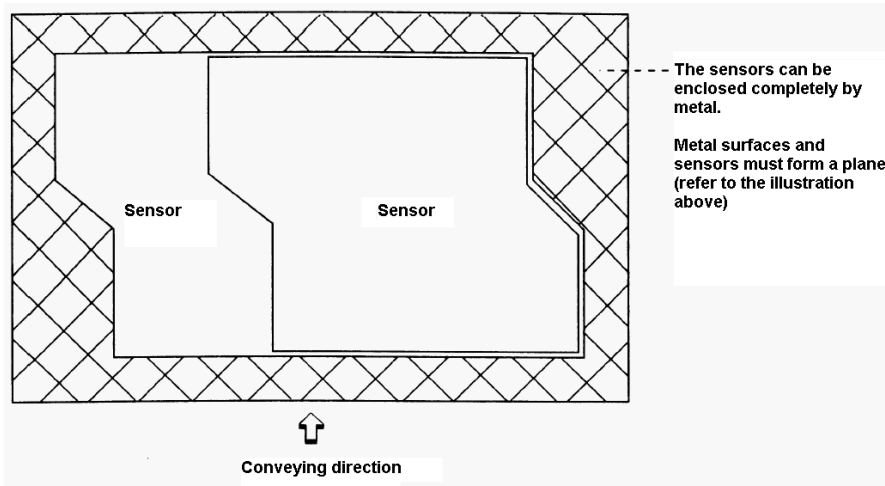

7.3 Assembly notes

When using devices with a conveyor exceptional care must be taken that the outer run cover as well as the drive lug is not made of metal or an electrically conductive material. In order to prevent faults care must be taken to ensure that no metallic contamination occurs on the conveyor or the detector. If required the device must be cleaned.

The following points must be observed for optimal detection results:

- Stable and shock free assembly on a suitable carrier plate or angle bracket
- External dynamic effects on the detector must be avoided
- The detector has to be mounted as close as possible to the material that has to be checked.
- If the outer run cover touches the detector a sliding plate must be mounted between the detector and the belt.
- The detector has to be mounted so that it cannot be influenced by vibration effects.

The following constructive measures can be taken in order to ensure the abovementioned points:

- Attach the detectors above rubber-metal connections and shock mounts. These rubber elements absorb high-frequency vibrations of the mounting frame or suchlike and keep them away from the flat sensor (e.g. blows or pushes against the belt)
- Assembly on a cellular-rubber covered plate as an alternative method
- The assembly on wood or chipboard is not recommended. On the other hand a stable metal plate is very suitable.
- Furthermore the direct contact between the sensor and the framework or suchlike should be avoided. If this is not possible the frame itself has to be decoupled from vibrations

8 Technical data flat sensors

8.1 Flat sensor AR

Assembly in Metal:	Flush
Speed of the parts to be detected:	Refer to the technical data of the control unit
Operating temperature:	- 10 °C bis + 60 °C
Protection class:	IP 67
Housing:	Cast aluminium
Sealing of the sensor surface:	Polyurethane
Connection:	2 m PVC-cable, 3 x 0.14 mm ²
Switching characteristic:	dynamic

8.2 Flat sensor SP

Assembly in Metal:	Flush, no isolation between housing and installation environment
Speed of the parts to be detected:	Refer to the technical data of the control unit
Operating temperature:	- 10 °C bis + 70 °C
Protection class:	IP 67
Housing:	Continuous cast aluminium profile
Height:	60,5 mm
Width:	210 mm
Possible Lengths:	200 – 850 mm in the step width 1 mm
Sealing of the sensor surface:	Polyurethane
Connection:	5 m PVC-cable, 8 x 0.14 mm ²
Switching characteristic:	dynamic

8.3 Flat sensor RE

Assembly in Metal:	Flush
Speed of the parts to be detected:	Refer to the technical data of the control unit
Operating temperature:	- 10 °C bis + 60 °C
Protection class:	IP 67
Housing:	Cast aluminium
Sealing of the sensor surface:	Polyurethane
Connection:	5 m PVC-cable, 3 x 0,14 mm ²
Switching characteristic:	dynamic

9 Control unit 10-fold

9.1 Field of application, scope of performance and supply

9.1.1 Field of application

The control unit 10-fold processes the signals of flat sensors AR, RE and SP from the Pulsotronic product range.

9.1.2 Scope of performance and supply

- Belt stop in case of metal detection
- Belt reverse after metal detection with an adjustable time from 1-60s
- Manual or automatic belt restart
- Transistor output pnp (source) 24V closing in case of metal detection
- Mains switch (housed variant)
- Button for belt start, belt stop and release after metal detection (housed variant)
- LED indication in the case of metal detection (housed variant)
- LED indication of the belt relay states (housed variant)
- Relay (make contact) for belt forward-run
- Relay (make contact) for belt reverse-run
- Relay (change over contact) for metal alarm
- Sensitivity adjustable by potentiometer
- Belt reverse run time adjustable by Potentiometer
- 4 belt speed ranges adjustable by DIP-switch

9.2 Technical Data control unit 10-fold

Voltage supply:	110V – 250V AC 50/60 Hz, 24V DC
Operating temperature:	- 10°C bis +50°C
Protection class:	IP 65 (housed variant), IP 20 (top-hat rail variant)
Housing material:	Powder coated metal (housed variant), Plastic (top-hat rail variant)
Connectable sensors:	Flat sensors from the AR, SP and RE range
Sensor inputs:	10
Relay outputs:	Dry contacts, 250V / 10A
Transistor output:	closing, pnp, 24V, Current load 20 mA, overload and short circuit proof, switching from 1.5 KΩ and up to 100 nF
Cable between sensors and control unit:	Max. 10m, only use shielded cable, connect the shield only at the sensor side
Speed of the metal parts to be detected	1m to 150m per minute
Operational readiness:	3 Sec. after provision of the supply voltage

When switching off the supply voltage the outputs are activated for a short time.

9.3 Operating elements and connection terminals

9.3.1 Internal operation elements and connection terminals

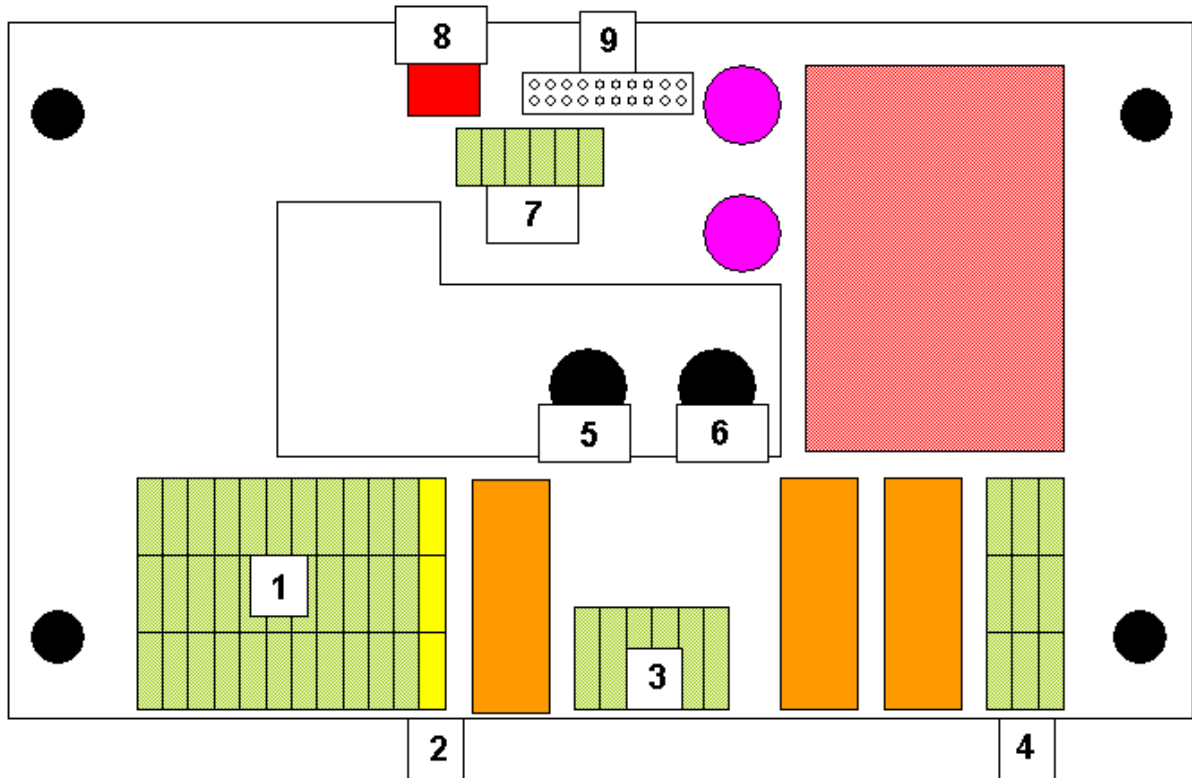

1. Sensor connection terminals
2. Operating voltage 24V DC and transistor output
3. Relay connection terminals
4. Operating voltage 230V AC
5. Sensitivity potentiometer
6. Belt reverse time potentiometer
7. Connector for button and LEDs
8. Dip-switch
9. Pin header for the output signals of the sensor channels

9.3.2 External operation elements (housed variant only)

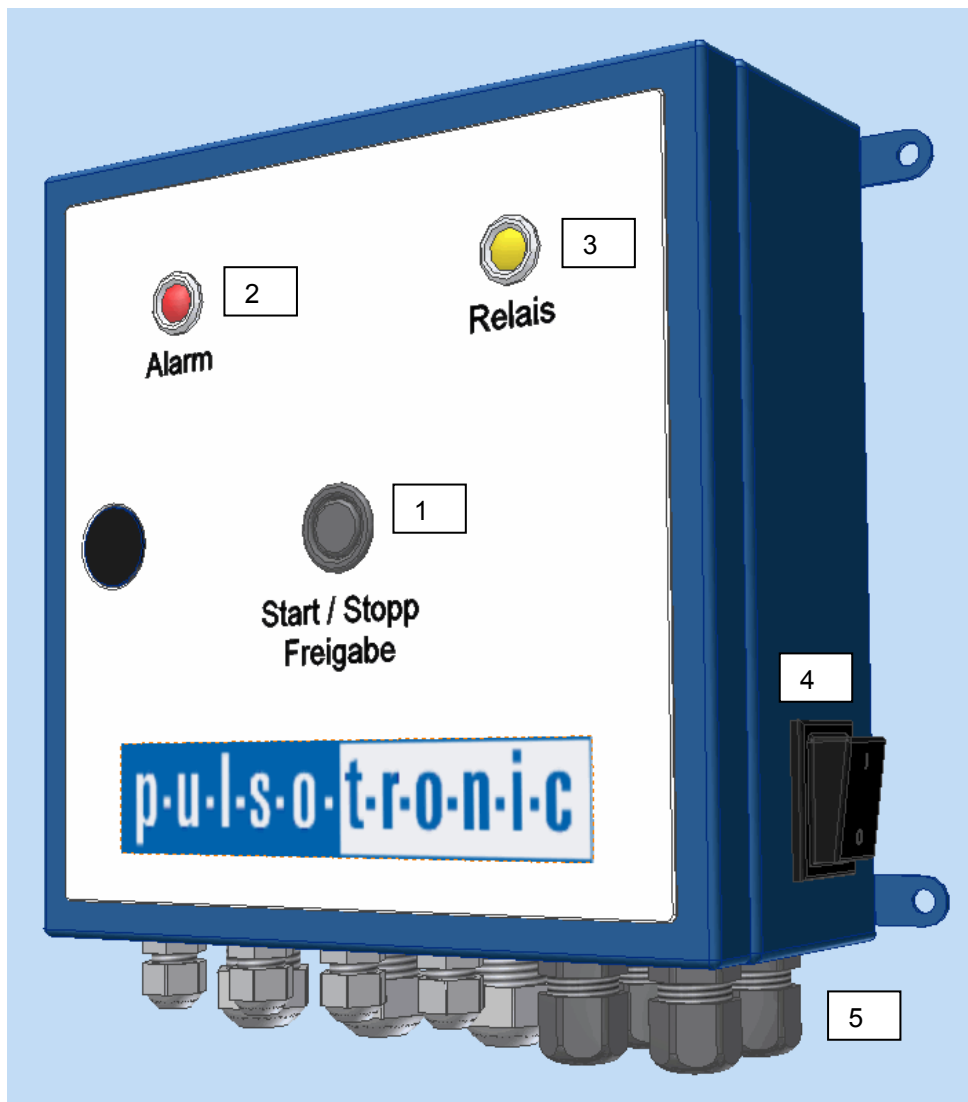

1. Button
2. Alarm LED
3. Relay LED
4. Mains switch
5. Cable glands

9.4 Terminal assignment

9.4.1 Supply voltage

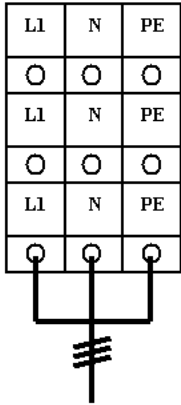

Mains supply 110V-250V AC 50/60 Hz

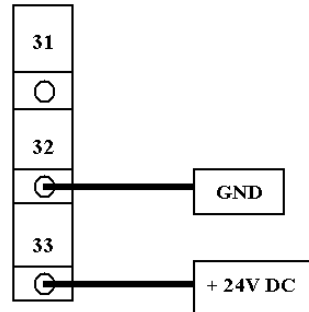

24 V DC

9.4.2 Sensor connections

9.4.2.1 Flat sensors AR

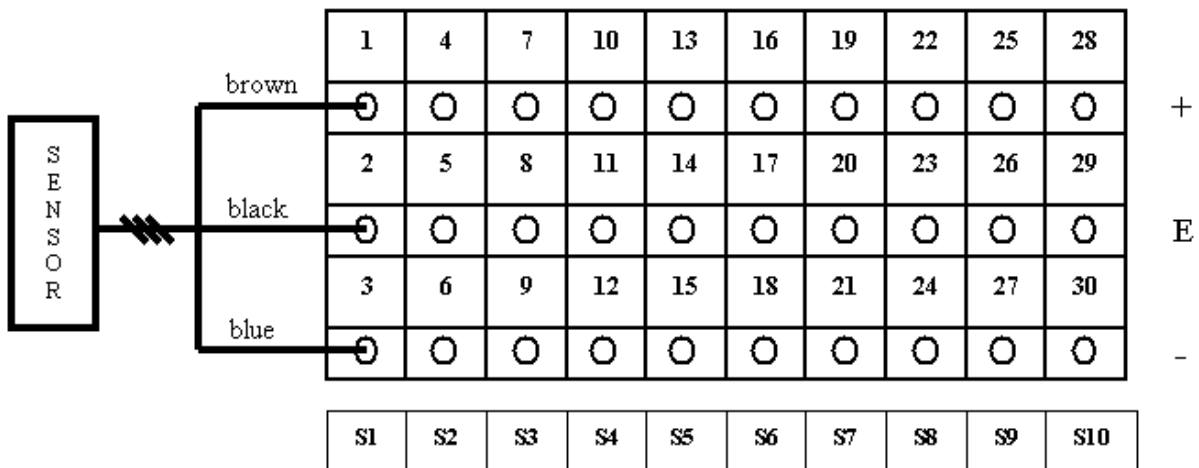

- Top view
- Sequence from left to right corresponds with sensors 1 to 10
- Terminals 1, 4, 7, 10, 13, 16, 19, 22, 25, 28 – supply voltage (+15V DC)
- Terminals 2, 5, 8, 11, 14, 17, 20, 23, 26, 29 – sensor signals
- Terminals 3, 6, 9, 12, 15, 18, 21, 24, 27, 30 – supply voltage (GND)

9.4.2.2 Flat sensors SP

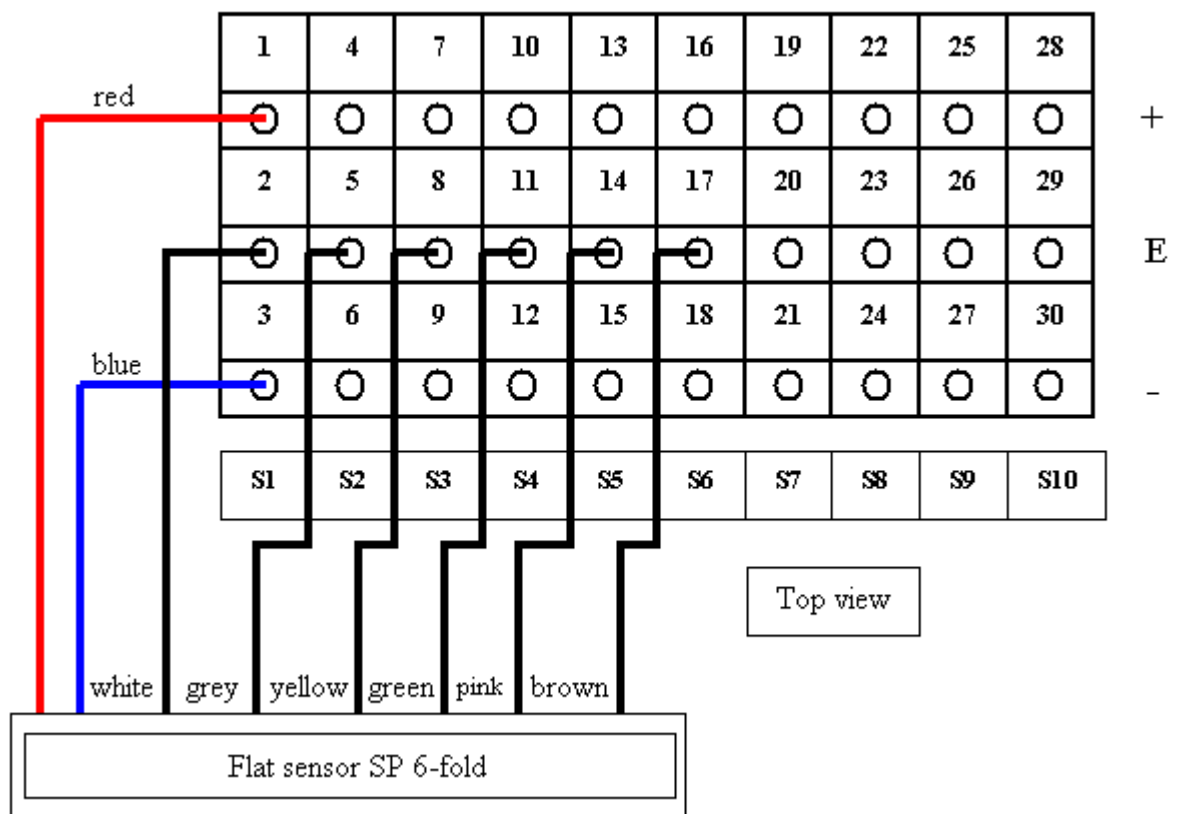
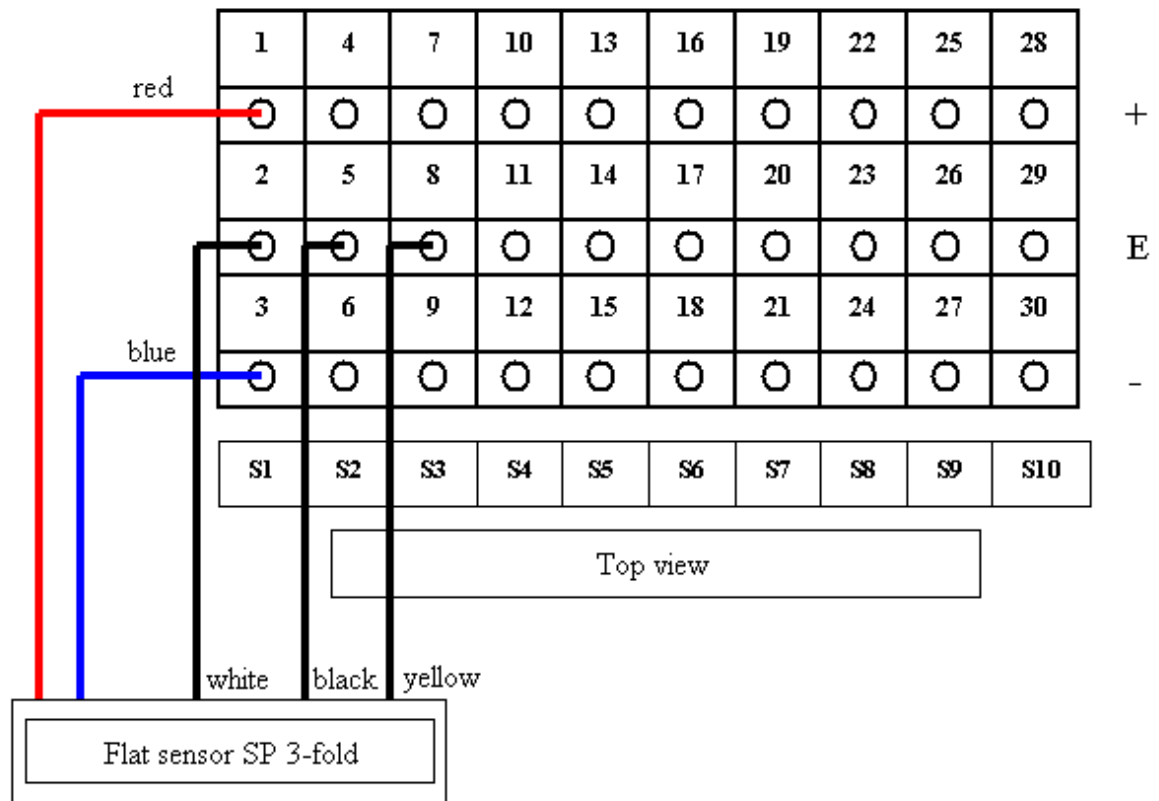

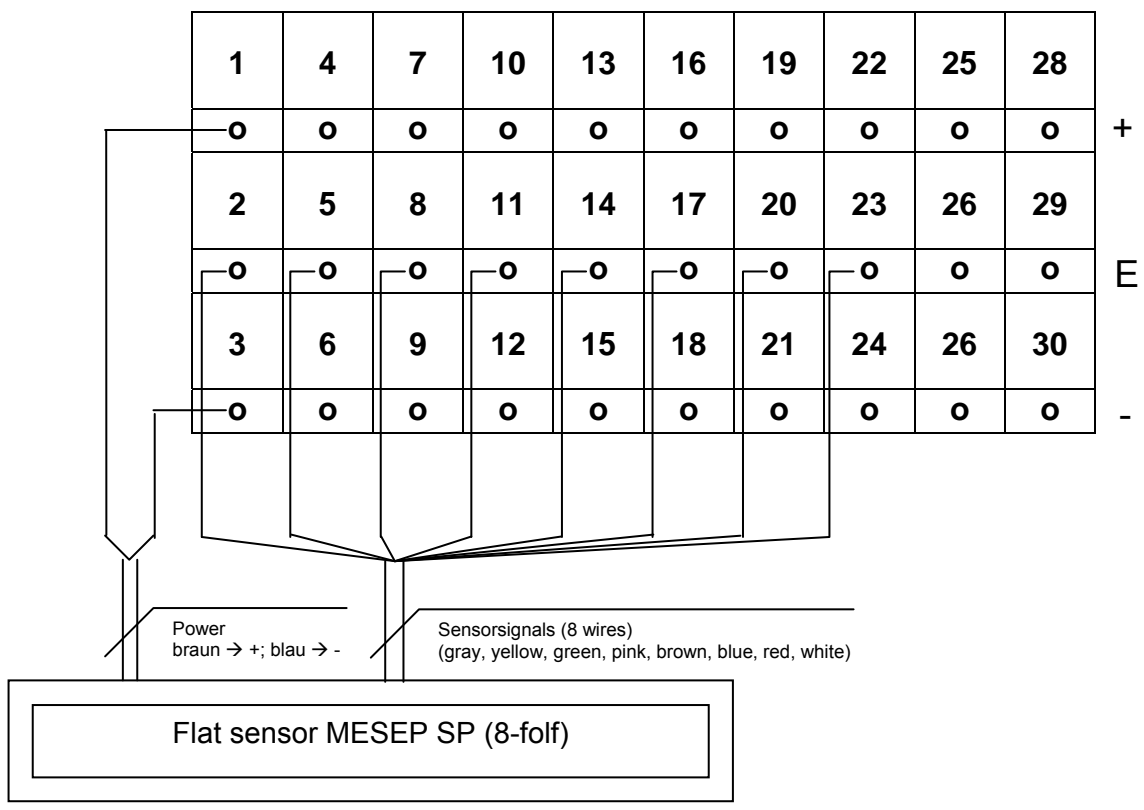

9.4.3 Relay connections

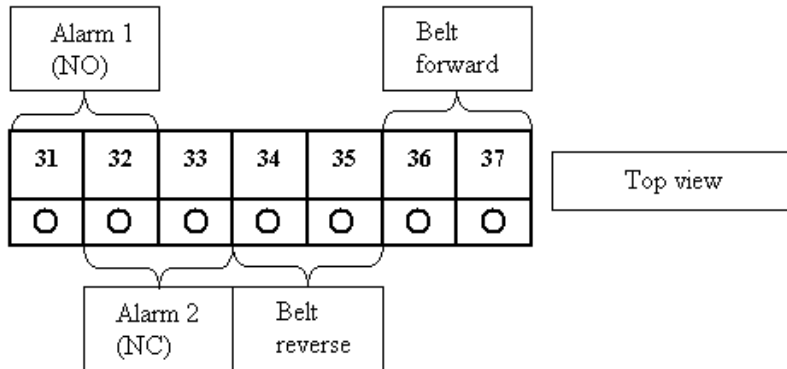

9.4.4 Transistor output

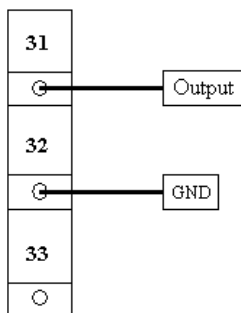

- transistor output pnp (source)
- open collector
- closing on alarm
- +24V
- overload and short circuit proof
- limited to 20mA

9.4.5 Operation elements

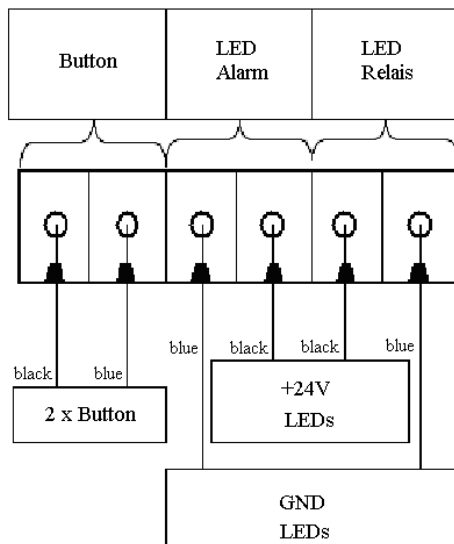

- The picture shows the foot contact with the connections (top view)

9.5 DIP-switch and potentiometer adjustment

9.5.1 DIP-switch adjustment

Automatic or manual release:

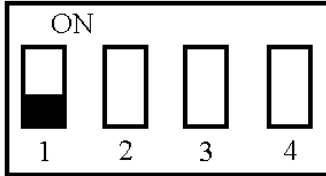

DIP 1 = OFF → manual release (button) after metal detection and device start

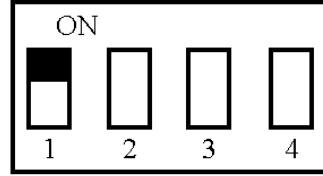

DIP 1 = ON → automatic release

The automatic release should only be used when it is assured that the detected metal part is completely driven out of the sensor area! If this is not assured then it cannot be guaranteed that an already detected piece of metal manages to pass the sensor!

Belt speed range selection:

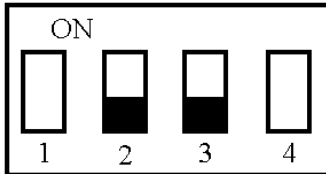

DIP 2 = OFF, DIP 3 = OFF → Belt speed max. 10m/min

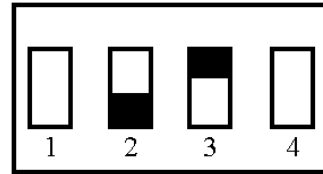

DIP 2 = OFF, DIP 3 = ON → Belt speed max. 30m/min

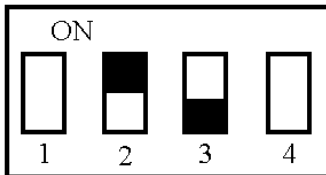

DIP 2 = ON, DIP 3 = OFF → Belt speed max. 100m/min

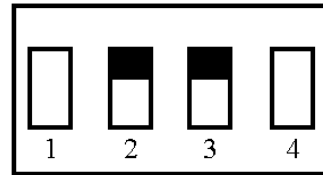

DIP 2 = ON, DIP 3 = ON → Belt speed max. 150m/min

Belt reverse run time:

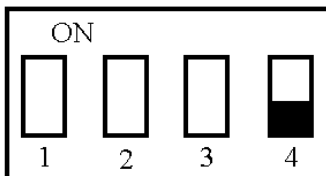

DIP 4 = OFF → Belt reverse run time 1...60s

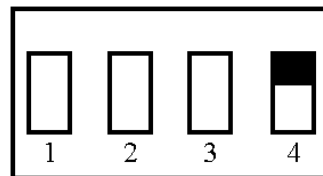

DIP 4 = ON → Belt reverse run time 1...10s

9.5.2 Potentiometer adjustment

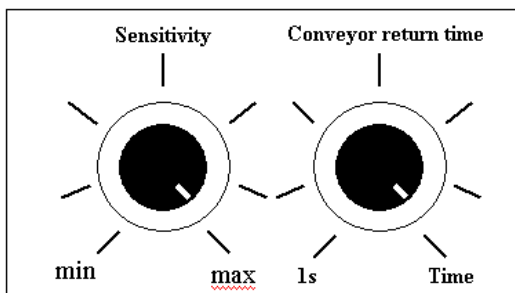

- Highest sensitivity when turned fully clockwise
- Depending on the DIP-switch setting „time“ corresponds to = 10s or 60s
- Belt reverse run time is 1 second when turned fully anticlockwise

9.6 Initial operation

Check before supplying power that the wiring has been carried out correctly and that the voltage supply for the motor is protected according to regulations.

1. Switch the device on. The relay LED flashes at a rate of 1 Hz.
2. If the automatic release is activated the belt starts after an initialization period of 2 seconds. If not the belt can be started with the button. When the belt is running the relay LED is illuminated permanently.
3. If the button is pressed while the belt runs the belt stops and the relay LED flashes. Pressing the button again will restart the belt.
4. If metal is detected the belt stops. Alarm LED, alarm relay and transistor output are constantly active.
5. Depending on the device adjustment the belt reverse run starts after about 250 ms for the set belt reverse run time.
6. If the button is pressed during reverse run the belt stops. It will only start to move if the button is pressed again.
7. If the automatic release is activated the belt continues with forward run immediately after the expiry of the belt reverse run time. If not the belt forward run can be started with the button. After the release the alarm LED, the alarm relay and the transistor output are deactivated, the relay LED is illuminated permanently (continue from Point 2).

The automatic release should only be used when it is assured that the detected metal part is completely driven out of the sensor area! If this is not assured then it cannot be guaranteed that an already detected piece of metal manages to pass the sensor!

10 Motor contactor and wiring

10.1 Technical data motor contactor

Connection technique			Screw terminals
Rated operational current			
AC-3 380 V 400 V	le	A	9
Max. rating for three-phase motors, 50 – 60 Hz			
AC-3 220 V 230 V	P	kW	2,2
AC-3 380 V 400 V	P	kW	4
AC-3 660 V 690 V	P	kW	4
AC-4 220 V 230 V	P	kW	1,5
AC-4 380 V 400 V	P	kW	3
AC-4 660 V 690 V	P	kW	3
Conventional thermal current I _{th} = I _e AC-1			
open	I _{th} =I _e	A	20
enclosed	I _{th} =I _e	A	16
Auxiliary contacts	NC = normally closed		1 NC

For further informations or a complete datasheet contact info@pulsotronic-anlagentechnik.de.

10.2 Wiring examples

10.2.1 Application example

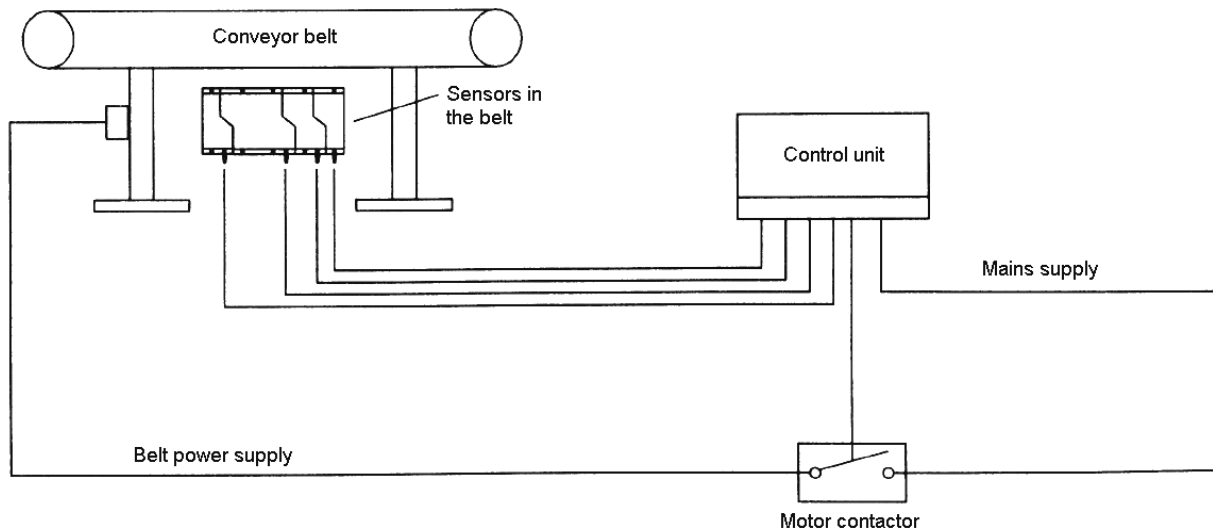

10.2.2 Conveyor belt with 1-phase motor – belt stop on metal detection

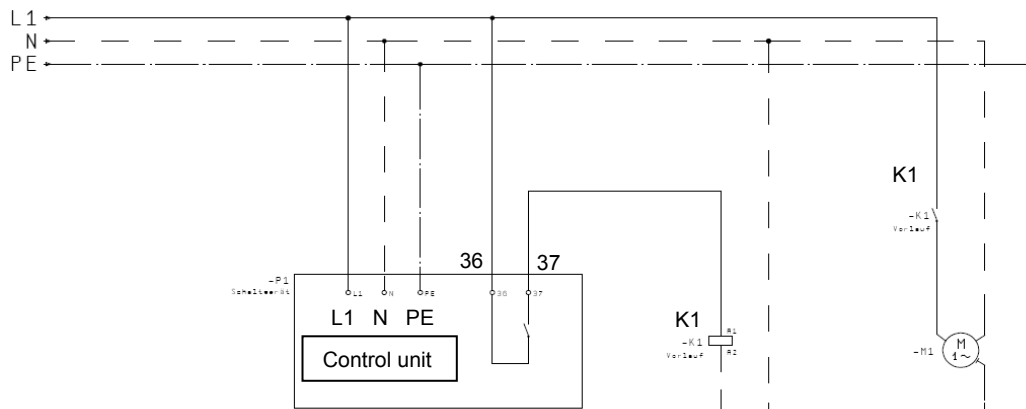

The motor can also be connected directly to N and 37 instead of the contactor K1.

10.2.3 Conveyor belt with 3-phase motor – belt stop on metal detection

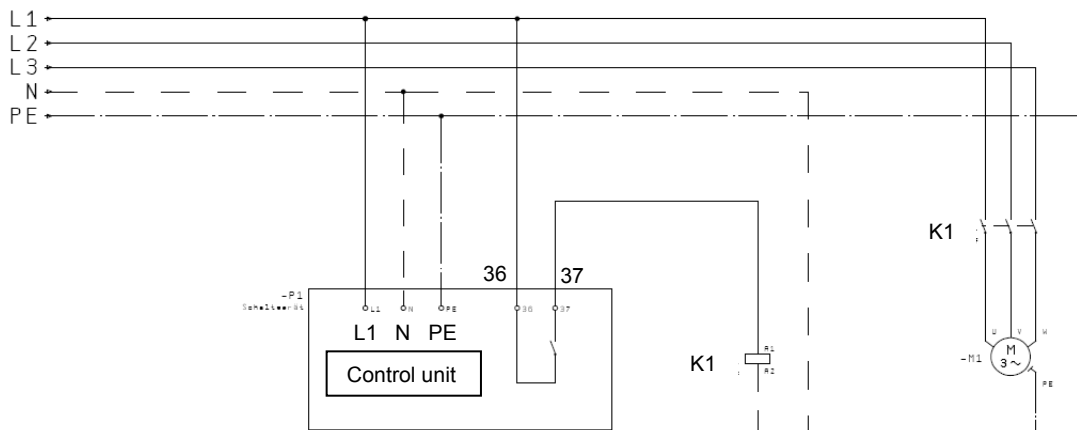

K1 → Forward run relay

10.2.4 Conveyor belt with 3-phase motor – belt reverse run on metal detection

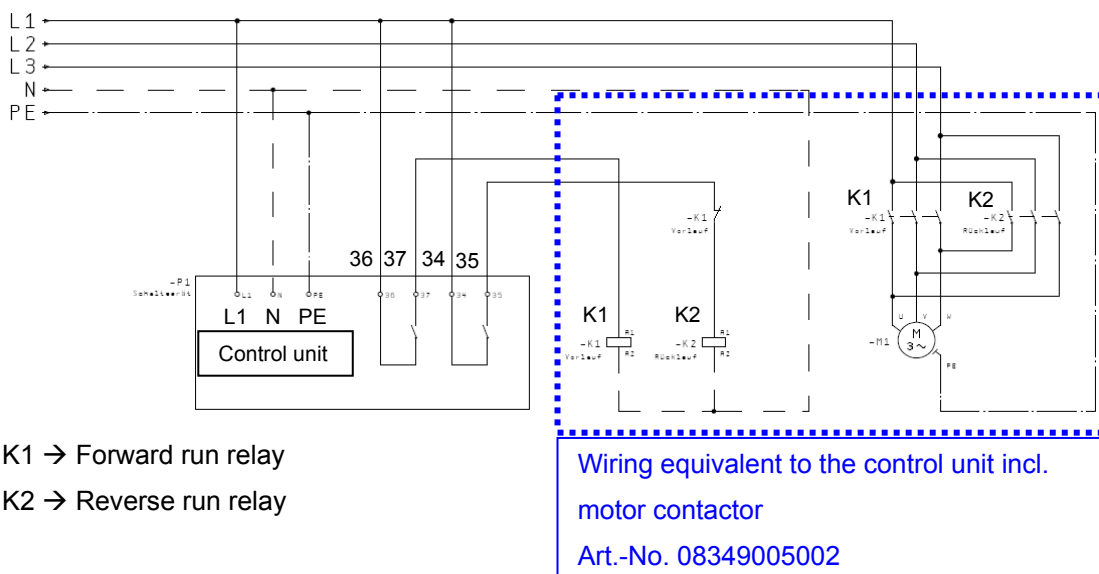

K1 → Forward run relay

K2 → Reverse run relay

Wiring equivalent to the control unit incl.
motor contactor
Art.-No. 08349005002

10.2.5 Series connection of control units – belt stop on metal detection

If for an application more than 10 flat sensors are required, then correspondingly more control units have to be used. These must be connected in series as follows:

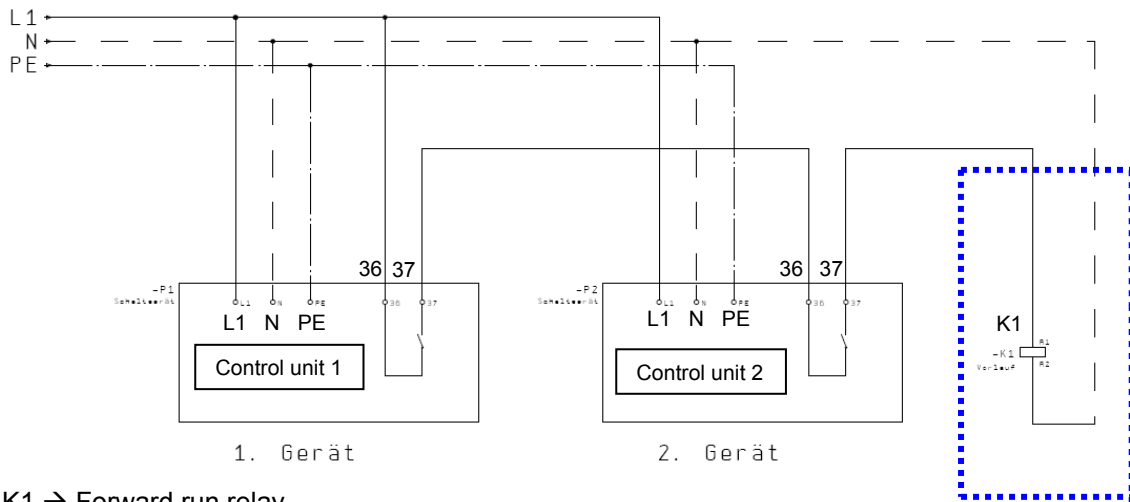

K1 → Forward run relay

10.2.6 Series connection of control units – belt reverse run on metal detection

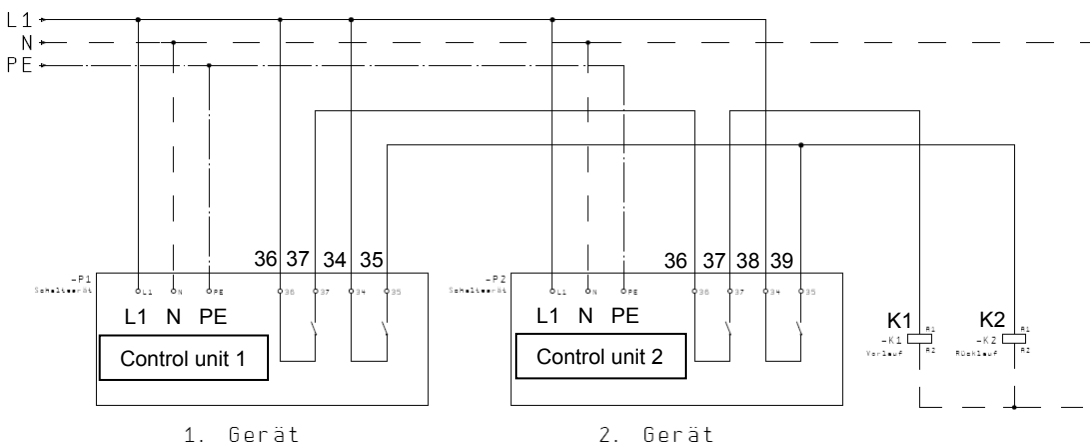

K1 → Forward run relay

K2 → Reverse run relay



The declaration of conformity can be obtained from the manufacturer.



Pulsotronic-Anlagentechnik GmbH

Neue Schichtstraße 7

D – 09366 Niederdorf

Telefon 03 72 96 / 9383 500

Telefax 03 72 96 / 9383 501

info@pulsotronic-anlagentechnik.de

www.pulsotronic-anlagentechnik.de